

# SET UP INSTRUCTION

## Expolinc Frame



Watch the setup movie!

### BASIC SET UP

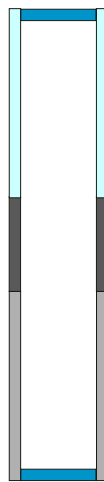
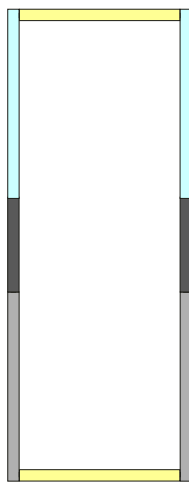
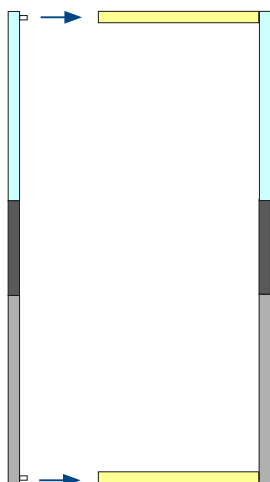
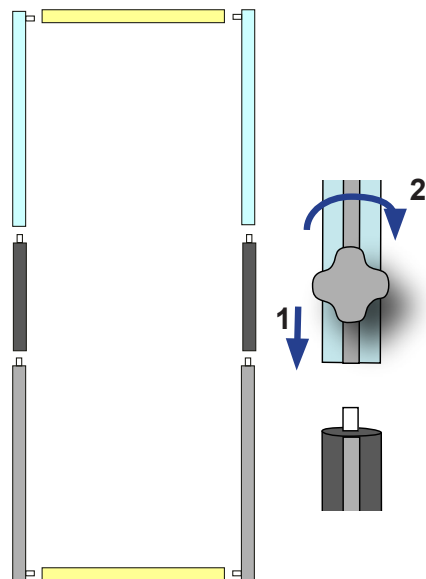
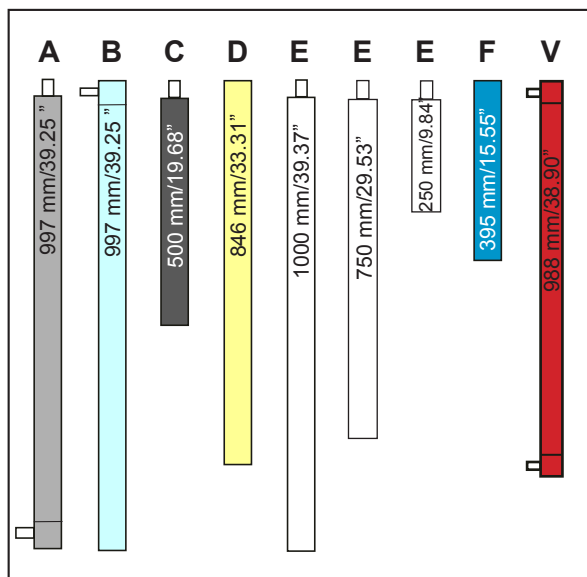

# WIDTHS & HEIGHTS

-   250 mm/9.84"
- 500 mm/19.68"
- 750 mm/29.52"
- 1000 mm/39.37"

500x1995 mm  
19,7x78,5"

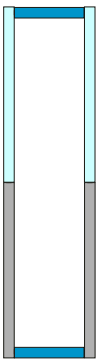

1950x1995 mm  
76,8x78,5"

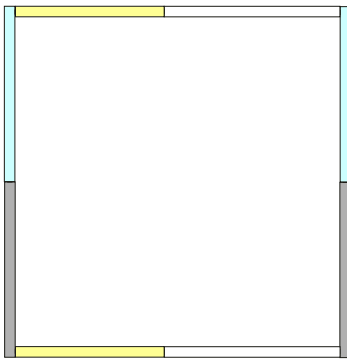

2450x2995 mm  
96,5x117,9"

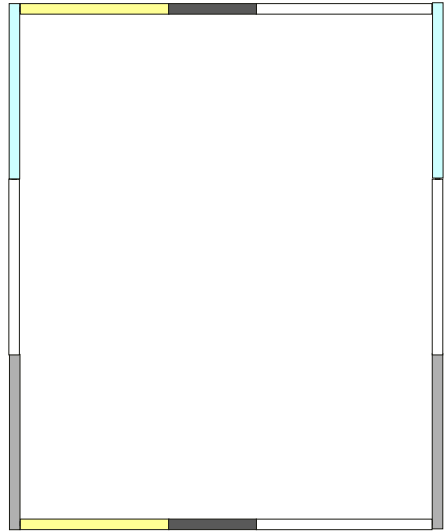

2950x2450 mm  
116,1x96,45"

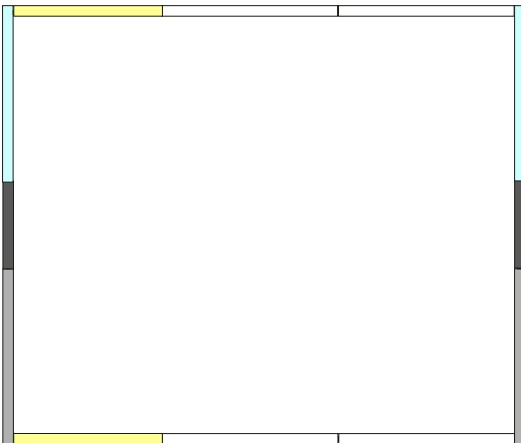

500x988 mm  
19,67x38,88"

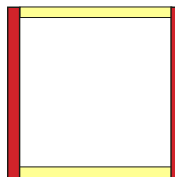

## SUPPORTING ROD

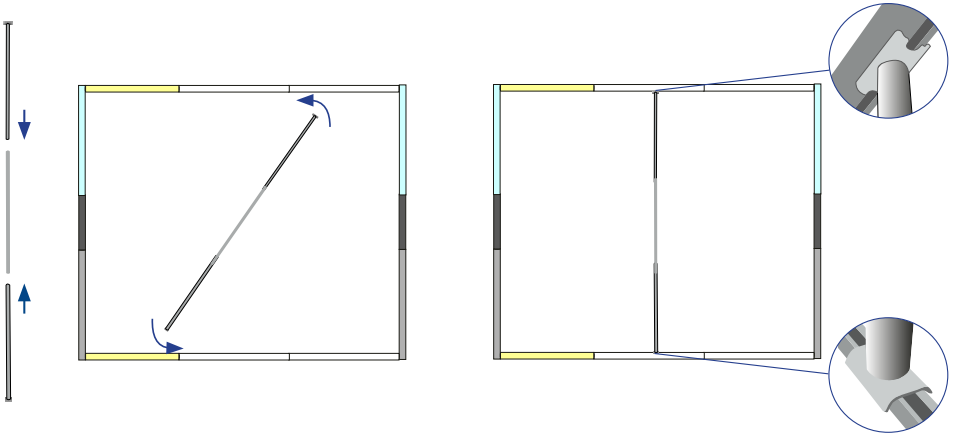

## MOUNT THE GRAPHIC

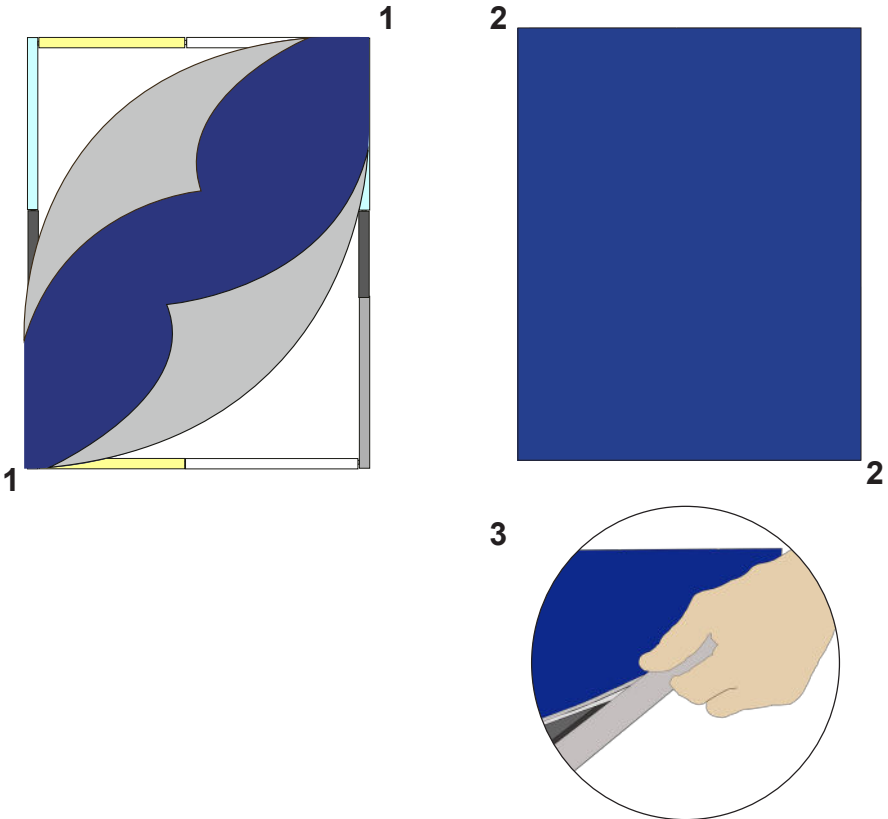

# STABILISING FEET

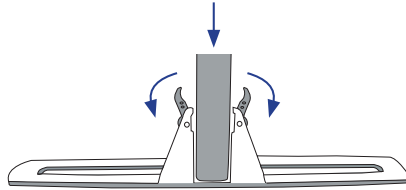

## Standard foot

Double-sided

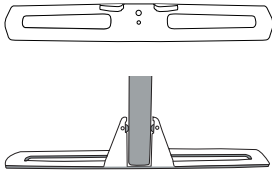

Single-sided

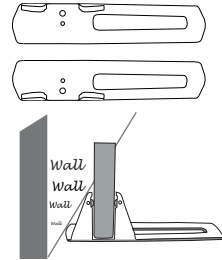

Standard foot      Standard foot

## Connecting foot

Double-sided

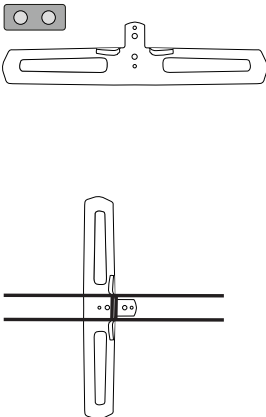

Single-sided

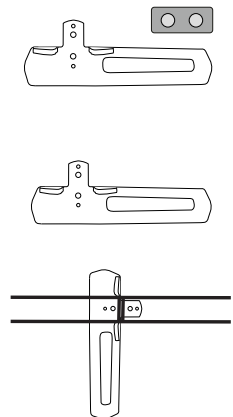

Standard foot      Connecting foot      Standard foot

# CONNECTORS

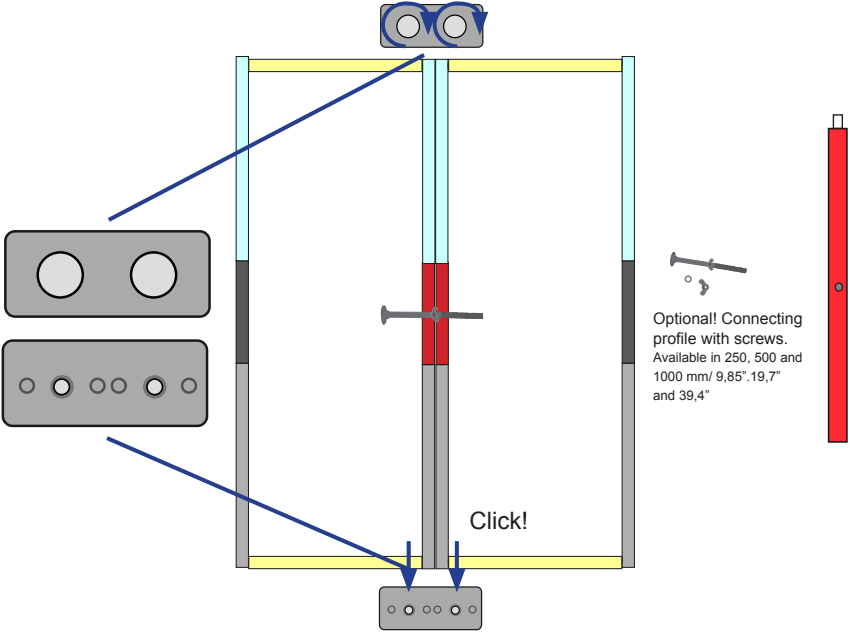

90° type A

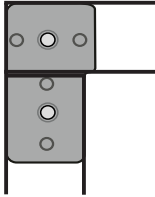

90° type B

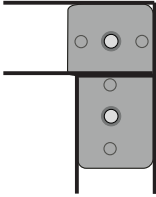

4 way

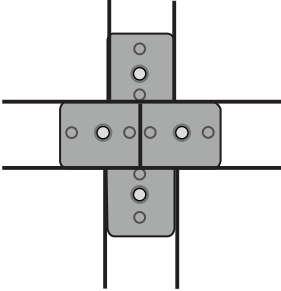

Straight

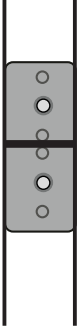

Triple A

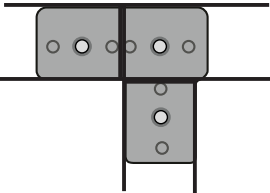

Triple B

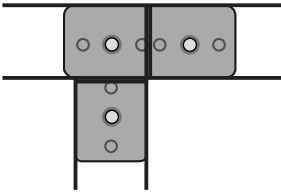

Triple C

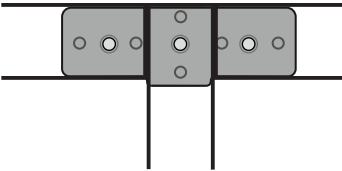

# SPOTLIGHT

